

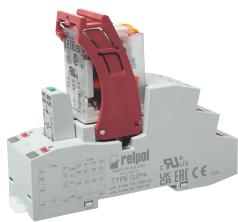

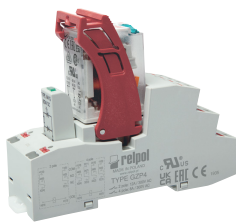

# PIR2 with socket Push-in GZP4 interface relays with Push-in terminals

R2N (AC) + GZP4



R2N (DC) + GZP4



- Interface relay **PIR2 with socket GZP4**, designed for continuous operation\*, consists of: electromagnetic relay **R2N**, grey plug-in socket **GZP4** (flammability class V-0), signalling / protecting module type **M...**, retainer / retractor clip **GZP4-0400** (plastic) • 35 mm rail mount acc. to EN 60715 or on panel mounting with two M3 screws
- May be linked with interconnection strips type **ZGZP...**
- Recognitions, certifications, directives: recognitions R2N, RoHS,   

## Contact data

Number and type of contacts		2 CO
Contact material		<b>AgNi</b>
Rated / max. switching voltage	AC	250 V / 300 V
Min. switching voltage		5 V
Rated load (capacity)	AC1	12 A / 250 V AC
	AC15	3 A / 120 V                      1,5 A / 240 V (B300)
	DC1	12 A / 24 V DC (see Fig. 3)
	DC13	0,22 A / 120 V                      0,1 A / 250 V (R300)
Motor load	acc. to UL 508	1/2 HP                      240 V AC, 4,9 FLA, single-phase motor ❶
	AC3 acc. to IEC 60947-4-1	0,37 kW                      240 V AC, single-phase motor
Min. switching current		5 mA
Max. make current		24 A
Rated current		12 A
Max. breaking capacity	AC1	3 000 VA
Min. breaking capacity		0,3 W
Contact resistance		≤ 100 mΩ
Max. operating frequency	• at rated load AC1	1 200 cycles/hour
	• no load	18 000 cycles/hour

## Coil data

Rated voltage	50/60 Hz AC	12, <b>24</b> , 48, 120, <b>230 V</b>
	DC	12, <b>24</b> , 48, 110 V
Must release voltage		AC: ≥ 0,2 U <sub>n</sub> DC: ≥ 0,1 U <sub>n</sub>
Operating range of supply voltage		see Tables 1,2 and Fig. 4, 5
Rated power consumption	AC	50 Hz: 1,6 VA                      60 Hz: 1,3 VA
	DC	0,9 W

## Insulation according to EN 60664-1

Insulation rated voltage		300 V AC
Rated surge voltage		4 000 V    1,2 / 50 μs
Overvoltage category		III
Insulation pollution degree		3
Dielectric strength	• between coil and contacts	2 500 V AC                      type of insulation: basic
	• contact clearance	1 500 V AC                      type of clearance: micro-disconnection
	• pole - pole	2 500 V AC                      type of insulation: basic
Contact - coil distance	• clearance	≥ 2,5 mm
	• creepage	≥ 4 mm

## General data

Operating / release time (typical values)		AC: 10 ms / 8 ms                      DC: 13 ms / 3 ms
Electrical life	• resistive AC1	> 10 <sup>5</sup> 12 A, 250 V AC
	• cosφ	see Fig. 2
Mechanical life (cycles)		> 2 x 10 <sup>7</sup>
Dimensions (L x W x H)		97 x 31 x 75,8 mm
Weight		117 g
Ambient temperature	• storage	-40...+85 °C
	(non-condensation and/or icing)                      • operating	coil AC: -40...+55 °C                      coil DC: -40...+70 °C
Cover protection category		IP 20                      EN 60529
Environmental protection		R2N: RTI                      GZP4: RT0                      EN 61810-1
Shock resistance	(NO/NC)	10 g / 5 g
Vibration resistance		5 g 10...150 Hz

The data in bold type relate to the standard versions of the relays. \*The relays are designed for continuous operation while maintaining the parameters declared in the data sheet. ❶ For single phase motors for 110-120 V AC do not use motors with higher FLA than given for 240 V AC.

# PIR2 with socket Push-in GZP4 interface relays with Push-in terminals

## Dimensions

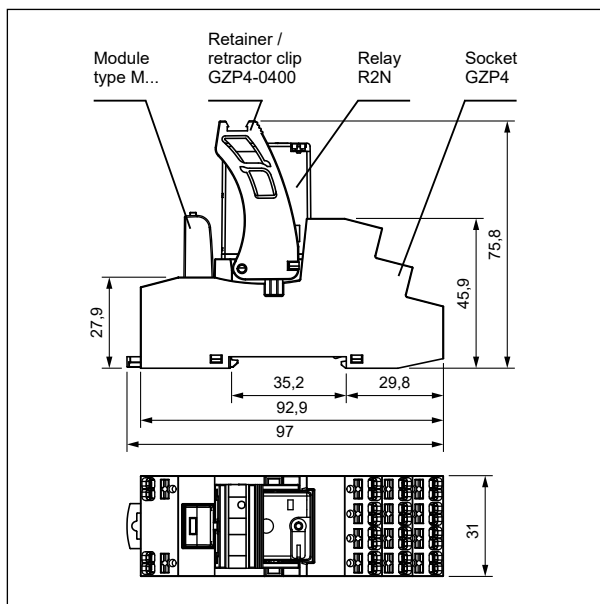

## Electrical life at AC resistive load. Switching frequency: 1 200 cycles/hour

Fig. 1

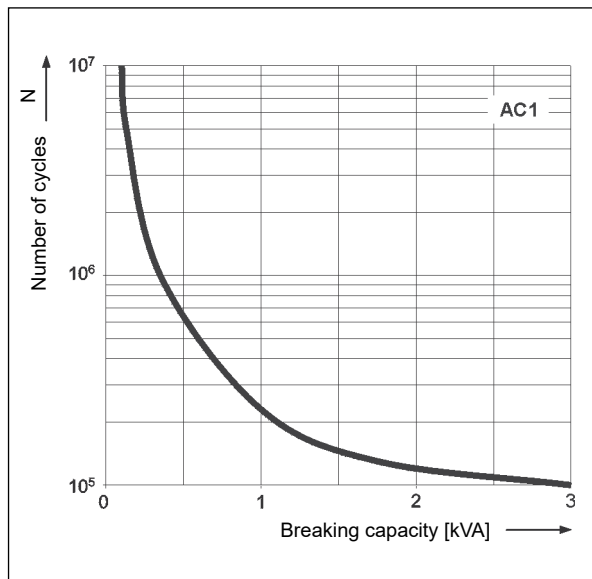

## Connection diagrams (Push-in terminals side view)

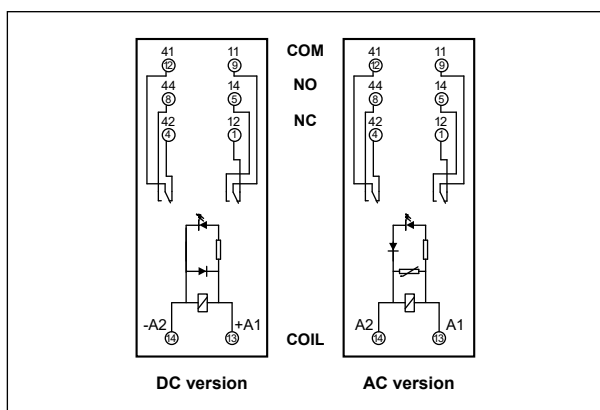

## Wire connection

The drawings present inserting wire into the Push-in terminal and removing wire using the button releasing a clamp (assembly without tools).

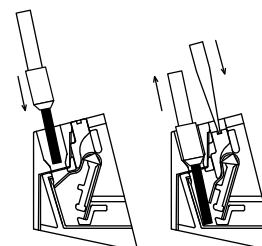

## Connecting accessories

- see page 6



ZGZP-8 GY grey  
ZGZP-8 BK black  
ZGZP-8 RD red  
ZGZP-8 BE blue



ZGZP-2 GY grey  
ZGZP-2 BK black  
ZGZP-2 RD red  
ZGZP-2 BE blue



ZGZP-2 GY grey  
ZGZP-2 BK black  
ZGZP-2 RD red  
ZGZP-2 BE blue

**Strips 8-poles ZGZP-8:** unlimited possibilities of connection configurations (bridging of: A1, A2, A1 & A2 together), fast, safe and easy bridging of signals on the coil.

**Strips 2-poles ZGZP-2:** free bridging of common input signals and terminals on the contact side, creating parallel connections of outputs in redundancy systems.

**Jumpers 2-poles ZGZP-2:** parallel connections of neighbouring poles in one socket GZP80 or GZP4 without use additional wiring, increasing the load capacity from 12 A to 16 A (PI85, PI85P).

**Electrical life reduction factor at AC inductive load**

Fig. 2

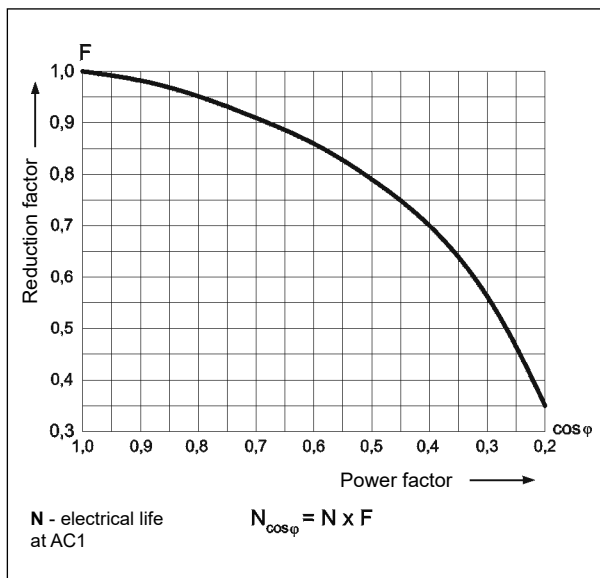

**Max. DC resistive load breaking capacity**

Fig. 3

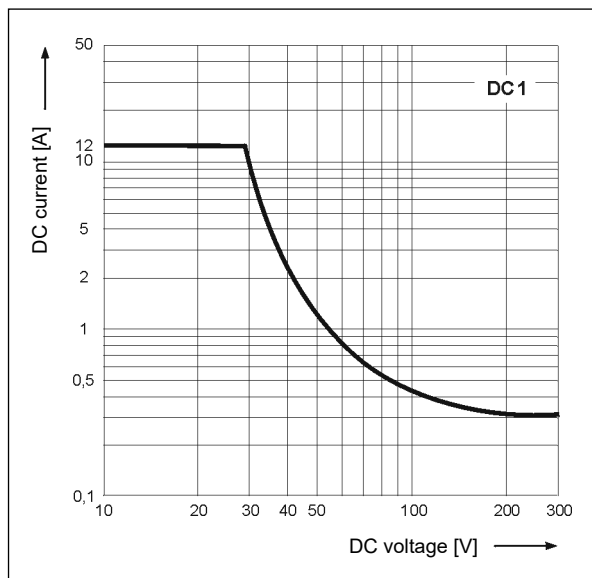

**Coil operating range - DC**

Fig. 4

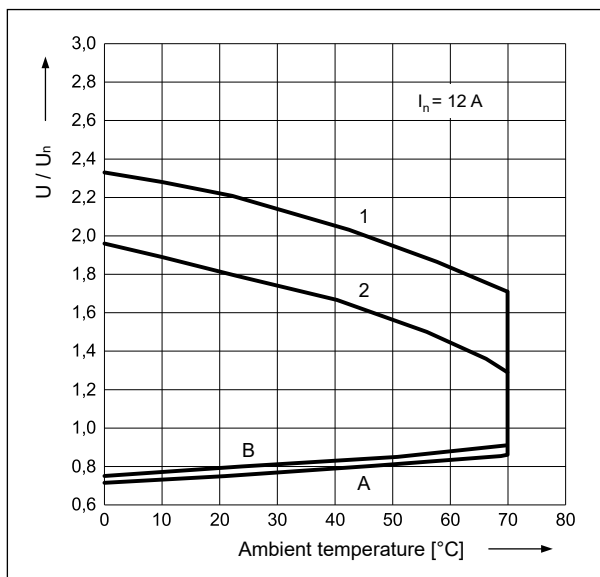

**Coil operating range - AC 50 Hz**

Fig. 5

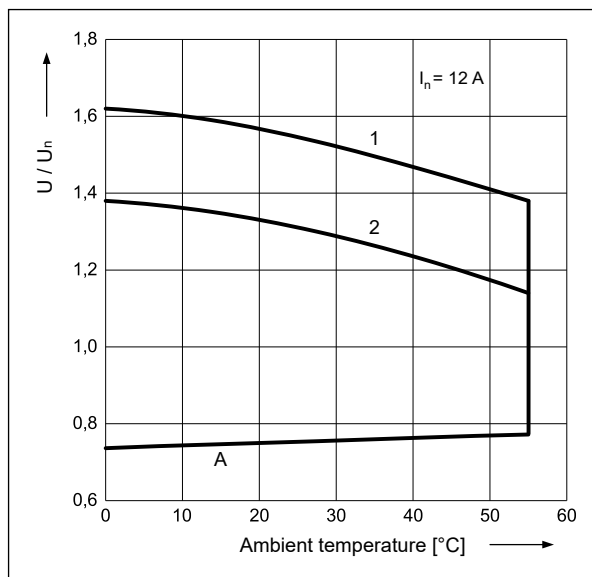

**Description of Fig. 4 and 5**

**A** - relations between make voltage and ambient temperature at no load on contacts. Coil temperature and ambient temperature are equal before coil energizing. Make voltage is not higher than the value read on Y axis (multiplication of rated voltage).

**B** - relations between make voltage and ambient temperature after initial coil heating up with  $1,1 U_n$  at continues load of  $I_n$  on contacts. Make voltage is not higher than the value read on Y axis (multiplication of rated voltage).

**1, 2** - values on Y axis represent allowed overvoltage on coil at certain ambient temperature and contact load:

- 1** - no load
- 2** - rated load

# PIR2 with socket Push-in GZP4 interface relays with Push-in terminals

## Mounting

Relays **PIR2 with socket GZP4** are designed for direct mounting on 35 mm rail mount acc. to EN 60715 or on panel mounting with two M3 screws. **Connections:** max. cross section of the cables: 2 x 1,5 mm<sup>2</sup> (ferrules without insulation), 2 x 1 mm<sup>2</sup> (ferrules with insulation), stripping length: 8...10 mm.

Plug-in sockets **GZP4** (flammability class V-0) may be linked with interconnection strips type **ZGZP...** Strip **ZGZP4-8** bridges common input signals, maximum permissible current is 10 A / 250 V AC, possibility of connection of 8 sockets. Strip **ZGZP4-2** bridges common input or output signals, possibility of connection of 2+n sockets. Jumper **ZGZP-2** bridges the neighboring poles of single socket **GZP4**. Colours of strips: **ZGZP...GY** grey, **ZGZP...BK** black, **ZGZP...RD** red, **ZGZP...BE** blue (see page 6).

Description plates **MP15**, snap into tall marker groove, compatible with the standard for DIN rail terminal blocks, should be ordered separately.



**Terminals directed to wiring ducts:** esthetic cabling management, easier content reading from markers on wires.



**Holes for test probes:** ergonomic, stable position of the probe in the socket, freedom to perform measurements and control.



**Space for label:** for self-adhesive paper, foil or polyester tapes (max. width 9 mm).

### Coil data - DC voltage version

Table 1

Coil code	Rated voltage V DC	Coil resistance at 20 °C Ω	Acceptable resistance	Coil operating range V DC	
				min. (at 20 °C)	max. (at 70 °C)
012DC	12	160	± 10%	9,6	13,2
<b>024DC</b>	<b>24</b>	<b>640</b>	<b>± 10%</b>	<b>19,2</b>	<b>26,4</b>
048DC	48	2 600	± 10%	38,4	52,8
110DC	110	13 600	± 10%	88,0	121,0

The data in bold type relate to the standard versions of the relays.

### Coil data - AC 50/60 Hz voltage version

Table 2

Coil code	Rated voltage V AC	Coil resistance at 20 °C Ω	Acceptable resistance	Coil operating range V AC	
				min. (at 20 °C)	max. (at 55 °C)
012AC	12	39,5	± 10%	9,6	13,2
<b>024AC</b>	<b>24</b>	<b>158</b>	<b>± 10%</b>	<b>19,2</b>	<b>26,4</b>
048AC	48	640	± 10%	38,4	52,8
120AC	120	3 770	± 10%	96,0	132,0
<b>230AC</b>	<b>230</b>	<b>16 100</b>	<b>± 10%</b>	<b>184,0</b>	<b>253,0</b>

The data in bold type relate to the standard versions of the relays.

# PIR2 with socket Push-in GZP4 interface relays with Push-in terminals

## Ordering codes

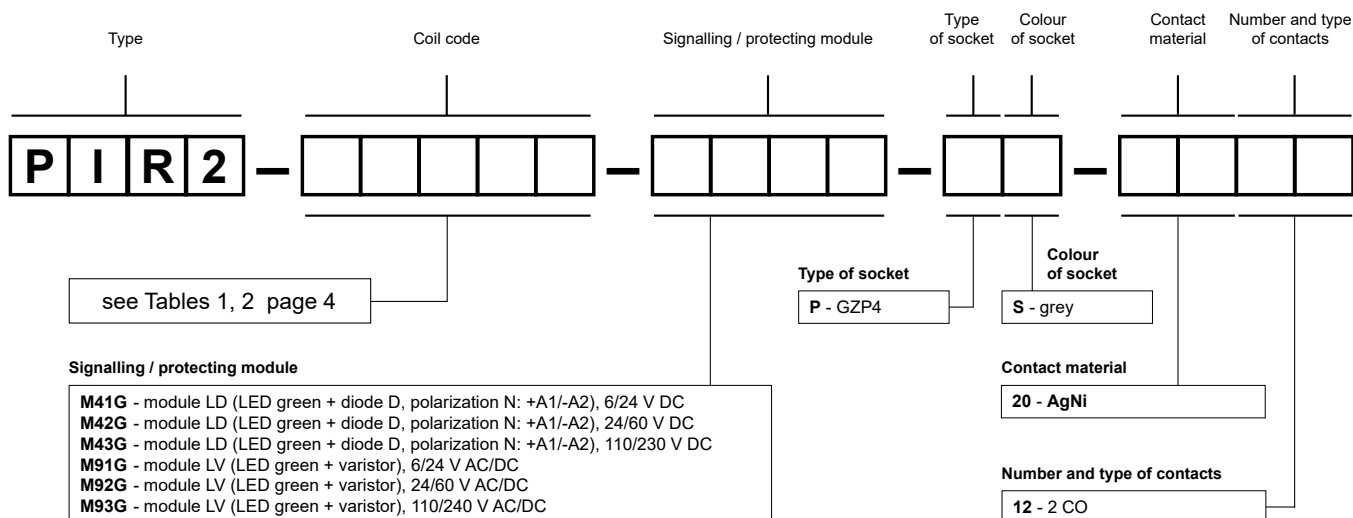

Examples of ordering codes:

**PIR2-024DC-M41G-PS-2012**

interface relay **PIR2** consists of: relay **R2N** (two changeover contacts, contact material AgNi, coil voltage 24 V DC), socket **GZP4** (grey, Push-in terminals), signalling / protecting module **M41G** (version LD), retainer / retractor clip **GZP4-0400** (red, plastic)

**PIR2-230AC-M93G-PS-2012**

interface relay **PIR2** consists of: relay **R2N** (two changeover contacts, contact material AgNi, coil voltage 230 V AC 50/60 Hz), socket **GZP4** (grey, Push-in terminals), signalling / protecting module **M93G** (version LV), retainer / retractor clip **GZP4-0400** (red, plastic)

## Interface relays Push-in

**PI84 (PI85, PI84P, PI85P)**  
 set: relay RM84  
 (RM85, RMP84, RMP85)  
 + socket GZP80

**PIR2 (PIR4) set:**  
 relay R2N (R4N)  
 + socket GZP4

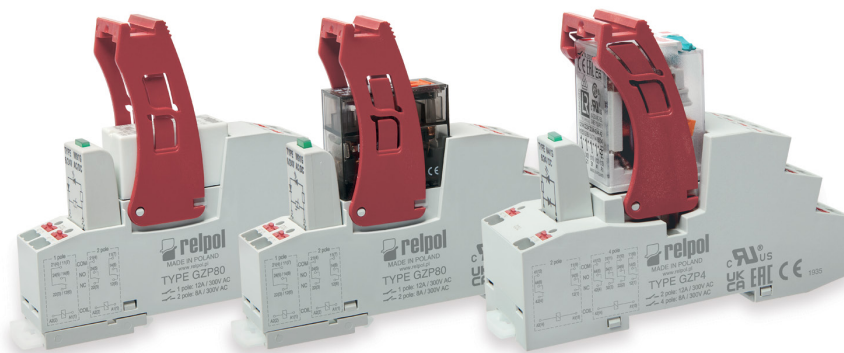

### PRECAUTIONS:

1. Ensure that the parameters of the product described in its specification provide a safety margin for the appropriate operation of the device or system and never use the product in circumstances which exceed the parameters of the product. 2. Never touch any live parts of the device. 3. Ensure that the product has been connected correctly. An incorrect connection may cause malfunction, excessive heating or risk of fire. 4. In case of any risk of any serious material loss or death or injuries of humans or animals, the devices or systems shall be designed so to equip them with double safety system to guarantee their reliable operation.

## Interconnection strips ZGZP... for sockets GZP4

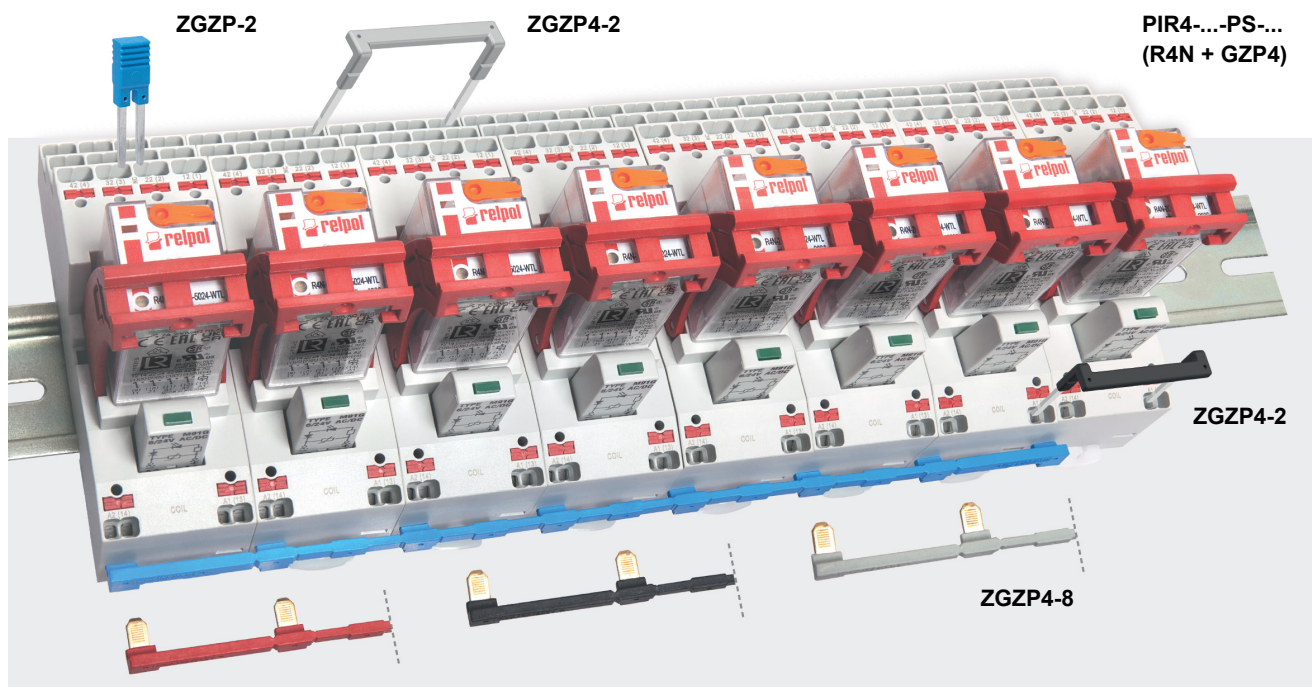

### ■ ZGZP... for:

Plug-in sockets	Relays for plug-in sockets	Interface relays ⓘ
GZP4	R2N	PIR2-...-PS-... (R2N + GZP4)
	R4N	PIR4-...-PS-... (R4N + GZP4)

ⓘ Interface relay **PIR2** (**PIR4**) is offered as a **set**: electromagnetic relay **R2N** (**R4N**) + plug-in socket **GZP4** + signalling / protecting module type **M...** + retainer / retractor clip **GZP4-0400**.

### ■ Interconnection strips ZGZP...

- designed for the co-operation with plug-in sockets of miniature industrial relays and with interface relays PIR2 and PIR4, which are equipped with screw terminals; sockets and relays are mounted on 35 mm rail mount acc. to EN 60715,
- strip **ZGZP4-8** bridges common input signals (coil terminals A1 or A2), maximum permissible current is 10 A / 250 V AC, possibility of connection of 8 sockets or relays,



- strip **ZGZP4-2** bridges common input signals (coil terminals A1 or A2) or output signals, possibility of connection of 2+n sockets or relays,



- jumper **ZGZP-2** bridges the neighboring poles of single socket **GZP4**.

